

FANTOM®

Hedge Trimmer

OWNER'S MANUAL

Model HT115H

120V., 60Hz., .65 Amp



CAUTION

Before using this Hedge Trimmer, read this manual and follow all its Safety Rules and Operating Instructions.

- Safety Instructions
- Accessories
- Assembly
- Operation
- Maintenance



Model HT115H

ONE (1) YEAR LIMITED WARRANTY

FANTOM warrants this product to be free from defects in material and workmanship for a period of one (1) year from the date of the original purchase, when utilized for normal household use, subject to the following conditions, exclusions and exceptions.

If your appliance fails to operate properly while in use under normal household conditions within the warranty period, return the complete appliance and accessories, freight prepaid to FANTOM, 94 Main Mill Street, Door 16, Plattsburgh NY 12901. If the appliance is found by FANTOM to be defective in material or workmanship, FANTOM will repair or replace it free of charge. Proof of purchase date and \$ 16.95 to cover the cost of return shipping and handling must be included. *

Non-durable parts including, without limitation, blades and electrical parts which normally require replacement are specifically excluded from warranty.

The liability of FANTOM is limited solely to the cost of the repair or replacement of the unit at our option. This warranty does not cover normal wear of parts and does not apply to any unit that has been tampered with or used for commercial purposes. This limited warranty does not cover damage caused by misuse, abuse, negligent handling or damage due to faulty packaging or mishandling in transit. This warranty does not cover damage or defects caused by or resulting from damages from shipping or repairs, service or alterations to the product or any of its parts, which have been performed by a repair person not authorized by FANTOM.

This warranty is extended to the original purchaser of the unit and excludes all other legal and/or conventional warranties. The responsibility of FANTOM if any, is limited to the specific obligations expressly assumed by it under the terms of the limited warranty. In no event is FANTOM liable for incidental or consequential damages of any nature whatsoever. Some states do not permit the exclusion or limitation of incidental or consequential damages, so the above may not apply to you.

This warranty gives you specific legal rights, and you may also have other rights which vary from state to state.

***Important:** Carefully pack item to avoid damage in shipping. Be sure to include proof of purchase date and to attach tag to item before packing with your name, complete address and phone number with a note giving purchase information, model number and what you believe is the problem with item. We recommend you insure the package (as damage in shipping is not covered by your warranty). Mark the outside of your package "ATTENTION CUSTOMER SERVICE". We are constantly striving to improve our products, therefore the specifications contained herein are subject to change without notice.



OWNERSHIP REGISTRATION CARD

Please fill out and mail the product registration card within ten (10) days of purchase. The registration will enable us to contact you in the unlikely event of a product safety notification. By returning this card you acknowledge to have read and understood the instructions for use, and warnings set forth in the accompanying instructions.

RETURN TO FANTOM: 94 Main Mill Street, Door 16, Plattsburgh, NY 12901

Model HT115H

Appliance model

Date purchased Name of store

Owner's name

Address City State Zip Code

SAFETY & WARNING INSTRUCTIONS



WARNING! THIS MACHINE CAN CAUSE SERIOUS INJURIES. When using the Hedge Trimmer basic safety precautions should always be followed to reduce the risk of fire, electric shock and personal injury. Carefully read and understand the entire owner's manual before using your Hedge Trimmer. Pay close attention to the Operating Instructions and Safety Warnings.

READ ALL INSTRUCTIONS BEFORE USING

1. Do **NOT** leave the hedge trimmer plugged in. Unplug from electrical outlet when not in use, changing blades or before servicing.
2. Avoid dangerous environments. Never operate your unit in damp or wet conditions. Moisture is a shock hazard.
3. Do **NOT** use the hedge trimmer in the rain.
4. Do **NOT** handle the unit with wet hands.
5. **Use the right tool for the right job.** Use the unit only as described in this manual. Do **NOT** use for any job except that for which it is intended.
6. Clear the area to be cut before each use. Remove all objects such as cords, lights, wires or string which can become entangled in the cutting blade.
7. Do **NOT** abuse the power cord. Do **NOT** pull or carry the unit by the power cord., use the power cord as a handle, close a door on cord, or pull by the cord around sharp edges or corners. Keep the cord away from heated surfaces, oil and sharp edges.
8. Do **NOT** unplug by pulling on the power cord. To unplug, grasp the plug, not the cord.
9. Keep hair, loose clothing, fingers and parts of the body away from openings and moving parts.
10. Do **NOT** allow to be used as a toy. Close attention is necessary when used by or near children.
11. Inspect all extension cords and the unit power connection periodically. Look closely for deterioration, cuts or cracks in the insulation. Also inspect the connections for damage. Replace the cords if any defects or damage appear.
12. Danger! Risk of cuts. Keep hands away from blades. Keep both hands on handles when power is on.
13. Do **NOT** attempt to remove cut material or hold material to be cut when the blades are moving. Make sure the unit is unplugged when clearing jammed material from blades. Do **NOT** grasp the exposed cutting blades or cutting edges when picking up or holding the unit.
14. **CAUTION:** Blades coast after the unit is turned off. Warning! To reduce the risk of electrical shock, use only with an extension cord intended for outdoor use such as SW-A, SOW-A, STW-A, STOW-A, SJW-A, SJOW-A, SJTW-A or SJTOW-A.



CAUTION: Blades coast after the unit is turned off.



WARNING: The operation of any hedge trimmer can result in foreign objects being thrown in the eyes. This can lead to severe eye damage. Before commencing power tool operation always wear safety glasses or goggles that are marked as meeting ANSI Z87.1 standards and a full face shield when needed.

SAFETY & WARNING INSTRUCTIONS

continued

- To reduce the risk of electrical shock, this unit has a polarized plug (one blade is wider than the other) and will require the use of a polarized extension cord. This unit plug will fit into a polarized extension cord only one way. If the plug does not fit, obtain a correct polarized extension cord. A polarized extension cord requires the use of a polarized wall outlet. This plug will fit into a polarized wall outlet only one way. If the plug does not fit, contact a qualified electrician to install the proper wall outlet. Do **NOT** change the unit plug, extension cord receptacle or extension cord plug in any way.
- Ground Fault Circuit Interrupter (GFCI) protection should always be provided on electrical circuits or outlets to be used for this unit.
- When using an extension cord, make sure that it is a cord that is heavy enough to carry the current that your unit will draw. An undersized extension cord will cause a drop in line voltage resulting in loss of power and overheating. The table below shows the correct size to use depending on the cord length and amperage rating.



WARNING

To reduce the risk of electrocution, keep all connections dry and off the ground. Do not touch the plug with wet hands.

	Extension Cord Length			
	25'	50'	100'	150'
AMPERAGE RATING	WIRE SIZE (AWG)			
1-10 AMPS	18	16	14	12

- Before each use, thoroughly inspect your unit for loose or damaged parts. Do **NOT** use until adjustments or repairs have been made.
- All guards and safety attachments must be installed properly before operating the unit.
- Use the unit in daylight or good artificial light.
- Keep all bystanders especially pets and children at least fifty (50) feet from the unit while using.
- To avoid unintentional starting of the unit, do **NOT** carry plugged-in unit with your finger on the safety switch. Be sure the unit is unplugged.
- Always remain alert and use common sense when using this unit. To prevent injury to yourself and to others, **NEVER** use the hedge trimmer when you are tired.
- DO NOT** operate this unit while under the influence of drugs, alcohol or medication.
- Wear safety glasses or goggles that are marked as meeting ANSI Z87.1 standards and ear/hearing protection when operating this unit. Wear a face or dust mask if the job is dusty.
- Do **NOT** over reach or use the hedge trimmer from unstable surfaces such as ladders, trees, steep slopes, rooftops, etc. Keep proper footing and balance at all times.
- When using the hedge trimmer to trim branches from trees, make sure that there are no overhead power lines.
- Wear heavy, long pants, boots, gloves and a long sleeve shirt. Do **NOT** wear loose clothing, jewelry, short pants, sandals or go barefoot. Secure hair above shoulder level.
- Always release the hand grip trigger when cutting is delayed or when walking from one cutting location to another.

OPERATING INSTRUCTIONS

- Press on the head angle release button to change the angle of the cutting head. There are 8 possible positions. (Fig. 4 & 5)

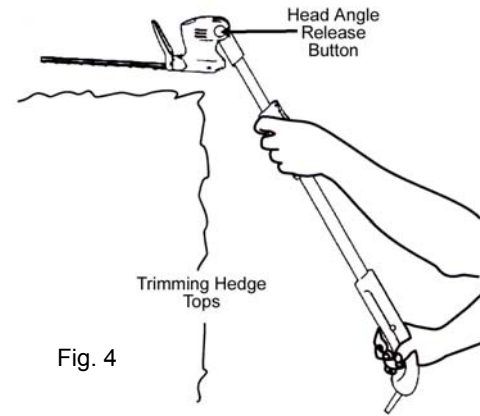

Fig. 4

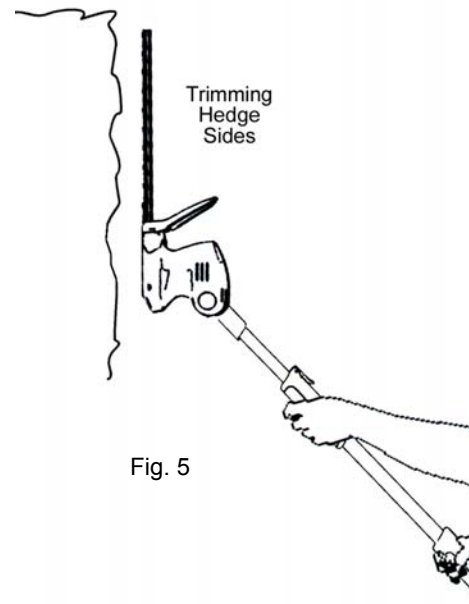

Fig. 5

- If desired, you can use a string to help you cut your hedge level. Decide how high you want the hedge to be and then stretch a piece of string along the hedge at this height. Trim the hedge just above this guide line. Trim the sides of the hedge so that the hedge will be a little narrower at the top.

NOTE: Do **NOT** try to cut stems that are larger than 3/8-inch thick or those obviously too large to feed into the cutting blade.

Care, Maintenance & Storage

WARNING: To avoid serious personal injury, be sure that the unit is unplugged before cleaning or performing any kind of maintenance on it.

- Oil the blades before each use and before storing for a long period of time. (Fig. 6)
- Do **NOT** use abrasive materials to clean the unit or immerse it in water or any other liquid.
- Clean the unit with a damp cloth. Do **NOT** use any strong detergents on the plastic housing or handles.
- Wipe off the unit with a clean, dry, soft cloth.
- Keep handles dry, clean and free from oil and grease at all times. Do **NOT** use on wet or steep/slippery ground.
- Do **NOT** attempt to cut string or fabrics with this unit.
- If parts need to be replaced or repaired, contact FANTOM customer service for information.
- Store the unit indoors, away from moisture and harmful substances such as solvents.
- Store the unit in a dry place, either locked up or up high to prevent unauthorized use or damage. Keep out of the reach of children.

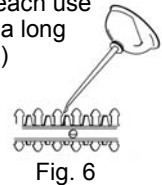

Fig. 6

OPERATING INSTRUCTIONS

Using Your Hedge Trimmer

WARNING: If any parts are missing, damaged or broken, **DO NOT** operate the hedge trimmer until they have been replaced. Failure to do so could result in possible serious injury.

WARNING: To prevent serious personal injury, always use both the front hand grip and the rear handle to hold the hedge trimmer during operation.

WARNING: To prevent serious personal injury, keep hands away from the blades. **DO NOT** attempt to remove cut material or hold material to be cut when blades are moving. Make sure that the unit is unplugged when clearing jammed material from blades. **DO NOT** grasp the exposed cutting blades or cutting edges when picking up or holding the unit.

WARNING: Never use the safety guard as a handle. Never grasp the unit by the safety guard. Failure to do so can result in serious possible injury.

WARNING: Clear the area to be cut before starting. Remove all objects such as cords, lights, wire or string which may become entangled in the cutting blade.

DANGER: If the blade becomes jammed on any electrical cord or line, **DO NOT TOUCH THE BLADE! IT CAN BECOME ELECTRICALLY LIVE AND VERY DANGEROUS.** Continue to hold your trimmer by the insulated handles and immediately disconnect the damaged electrical cord or line from the power source. Failure to heed this will result in serious personal injury and possibly death.

Use the hedge trimmer for trimming and the forming of hedges, bushes and shrubs with a branch diameter of up to 3/8 inch.

For your protection there is safety guard between the front hand grip and the blade.

1. Attach the power cord to an extension cord.
2. Secure the extension cord to the clip holder. (Fig. 3)

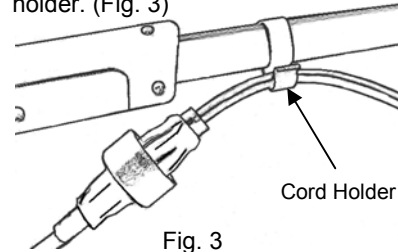

3. Adjust the length of the extension handle.
4. Remove the blade cover.
5. Plug the extension cord into an electrical outlet.
6. With the blade directed away from you, hold the unit by the rear handle and the front hand grip.
7. Press and hold the safety switch and then press on the handle trigger.
8. Start the unit away from the hedges that you wish to trim.
9. If you hear the motor change pitch dramatically while cutting, it may be overloaded. Check to see if the hedge or bush that you are trimming is very thick or dense. Doing a rough cut to trim about half the height that you want is recommended to help reduce the load on the motor. The maximum thickness of a branch that the hedge trimmer will cut is approximately 3/8 inch. Keep from trimming too much at one time as this can cause the blades to bind and slow, reducing the cutting efficiency. Do **NOT** force the unit through dense growth. If your blades slow down, reduce your pace.

SAFETY & WARNING INSTRUCTIONS continued

30. Keep cutting blades clean of vegetation and other materials. Blades may become clogged with debris.
31. When using the hedge trimmer, always hold the unit with both hands. Keep a firm grip on the front handle and on the rear handle. **NEVER** hold the hedge trimmer by the safety guard or use the safety guard as a handle.
32. **NEVER** force the unit. It will do the job better and with less chance of injury at a rate for which it was designed.
33. If you strike or become entangled with a foreign object, stop the unit immediately and check for damage. Do **NOT** operate the hedge trimmer with loose or damaged parts.
34. Maintain the hedge trimmer with care. Keep the cutting blades sharp and clean for best performance and to reduce the risk of injury. Follow instructions for lubricating and changing cutting blades. Keep handles dry, clean and free from oil and grease. Always use a clean cloth when cleaning. Never use brake fluid, gasoline, petroleum-based products, or any strong solvents to clean your hedge trimmer.
35. This appliance is double insulated to protect you from electrical shock.
36. Store the unit in a dry place either locked up or in a high shelf out of the reach of children to prevent unauthorized use or damage.
37. **NEVER** douse or squirt the unit with water or any other liquid. Keep handles dry, clean and free from debris. Clean after every use. See cleaning and storage section for further instructions..
38. Do **NOT** operate this unit in explosive atmospheres, such as in the presence of flammable liquids, gases or dust.
39. Maintain hedge trimmer with care. Keep cutting edge sharp and clean for best performance and to reduce the risk of injury. Follow instructions for lubricating.
40. When operating the hedge trimmer, keep the extension cord behind the hedge trimmer. Never drape it over the hedge to be trimmed.

WARNING

SERVICING OF A DOUBLE-INSULATED APPLIANCE.
In a double-insulated product, two systems of insulation are provided instead of grounding. No grounding means are provided for a double-insulated product, nor should grounding means be added to the product. Servicing a double-insulated product requires extreme care and knowledge of the system and should be done only by qualified service personnel. Replacement parts for a double-insulated product must be identical to the original parts. A double-insulated product is marked with the words "double Insulation" or "Double Insulated". Product may also be marked with symbol shown.



SAVE THESE INSTRUCTIONS For Household Use Only

GETTING TO KNOW YOUR HEDGE TRIMMER

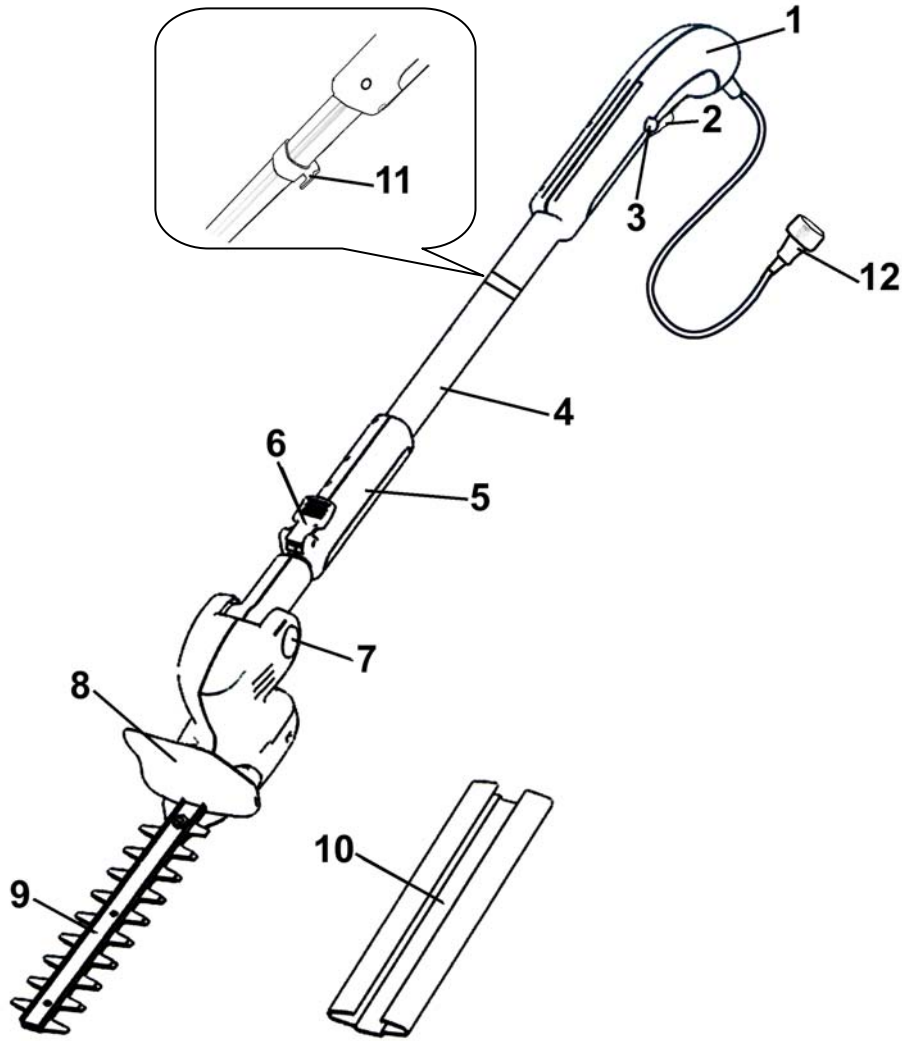

- | | |
|--------------------------|------------------------------|
| 1. Rear Handle | 7. Head Angle Release Button |
| 2. Handle Trigger | 8. Safety Guard |
| 3. Safety Switch | 9. Blades |
| 4. Extension Handle | 10. Blade Cover |
| 5. Front Hand Grip | 11. Cord Holder |
| 6. Extension Handle Lock | 12. Power Cord |

Illustrations may differ from actual product.

Technical Specifications

Voltage: 120V., 60Hz.
Power: .65 Amp

OPERATING INSTRUCTIONS

Extension Handle Adjustment

⚠ WARNING: Remove the plug from the power source before making adjustments to the hedge trimmer. This will help prevent accidental starting of the unit which could result in serious injury.

The handle length on this unit can be varied allowing you to reach difficult places without the use of a ladder.

To adjust the length:

1. Grip the head of the hedge trimmer firmly and lift the extension handle lock. (Fig. 1)
2. Pull the extension handle to the desired length.
3. When you have the length that you want, press the handle lock down firmly to lock the extension handle in place. (Fig. 1)
4. When you have finished using the hedge trimmer, lift the extension handle lock and retract the handle before storing.

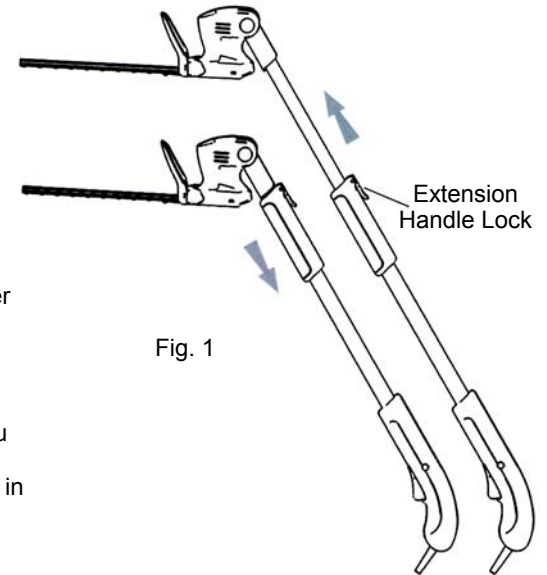

Fig. 1

Starting & Stopping The Hedge Trimmer

The Hedge Trimmer is designed with a safety switch to prevent accidental starting of the unit.

To start the hedge trimmer:

1. Remove the blade cover.
2. Connect the power plug into the electrical outlet.
3. Press the and hold the safety switch on the side of the handle, then press the handle trigger. (Fig. 2)
4. Continue to press on the handle trigger and release the safety switch.
5. To stop the blades, release the handle trigger.

IMPORTANT: When releasing the handle trigger, wait for the blades to stop completely before removing your hands from the handle.

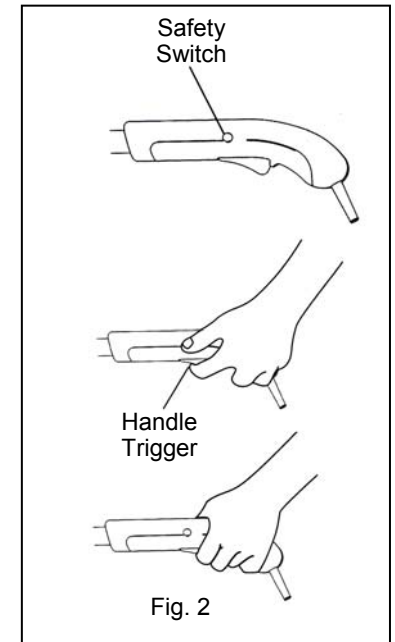

Fig. 2